

户外机柜交流空调器-M系列

Outdoor Cabinet AC Air Conditioner-M Series

产品简介

应用范围

本产品广泛应用于户外通讯机柜、电池柜、电器柜、工业控制柜等需要散热的场合；

设计专长

- 实现遥测、遥信、遥调，可实现多重自动保护和全面的故障自诊断功能；
- 精湛工艺及高质量国际名牌配件确保产品更加稳定可靠；
- 多重保护功能、可视化人机界面、RS485接口(MODBUS-RTU)；
- 适合T3高温工况、R134a环保制冷剂；
- 多重保护功能；
- LED数码管显示，现场参数可设置；
- 干接点告警输出，常开/常闭可选；
- 加热功能可选。

Product Introduction

Range of application

This series of products can be widely used in enclosed area for climate control, such as wireless communication cabinet, battery cabinet, industry control cabinet etc;

Product Design Feature

- Remote measuring, remote communication, remote control, which can realize multiple automatic protection and comprehensive self-testing function;
- Strict process control and famous brand components to ensure high quality and reliability of this product;
- Multiple self-protection design & Interchangeable monitoring interface, RS485 communication port (MODBUS-RTU protocol);
- Fit for harsh condition (T3), R134a refrigerant ;
- Multiple self protection design;
- LED Display, all the settings can be changed at the field;
- Dry contact alarm output, NO/NC optional;
- Heat function optional.

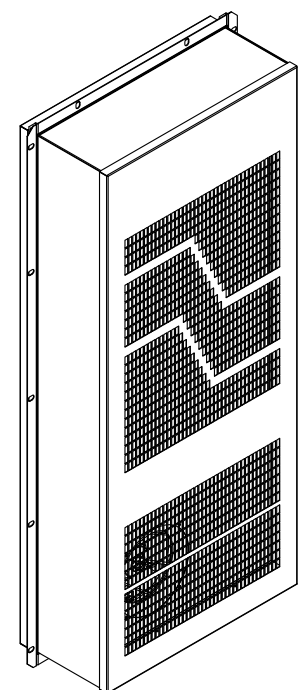
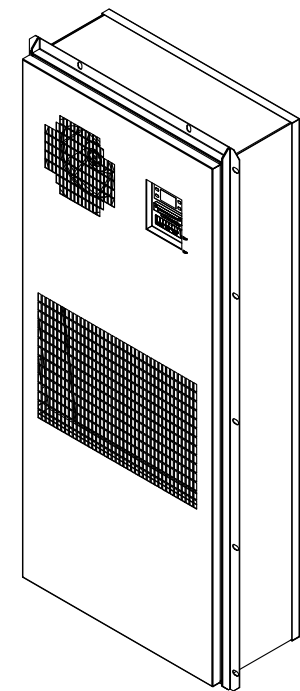

技术参数 / Technical Parameters

产品名称	Name	户外机柜空调器/Outdoor Cabinet Air Conditioner		
型号	Model	JGLC A 030/M/S/A	JGLC A 030/M/D/A	JGLC A 030/M/E/A
固定方式	Mounting Method	侧装	门装	半嵌入
		Side Mounting	Door Mounting	Semi-embedded Mounting
电源	Power Supply	230VAC±15% 50Hz/60Hz		
制冷量	Cooling Capacity	3000W@L35/L35		
功耗	Power Consumption	1300W@L35/L35		
制冷量	Cooling Capacity	1900W@L35/L55		
功耗	Power Consumption	1640W@L35/L55		
内循环风量	Internal Airflow	720 m ³ /h		
工作温度范围	Working Temperature Range	-40℃~+55℃		
最大噪音	Max Noise Level	67dB (A)		
IP等级	IP Grade	IP55		
净重	Net Weight	55Kg		
制冷剂	Refrigerant	R134a		
外形尺寸	Dimensions	1154x489x225(mm,HxWxD)		
CE和环保	CE&RoHS Compliant	符合/YES		
表面处理	Surface Treatment	Outdoor type powder coating, standard color: RAL7035		
加热器	Heater	可选择(800W) / Optional(800W)		

冷量曲线/Cooling Capacity Chart

功耗曲线/Power Consumption Chart

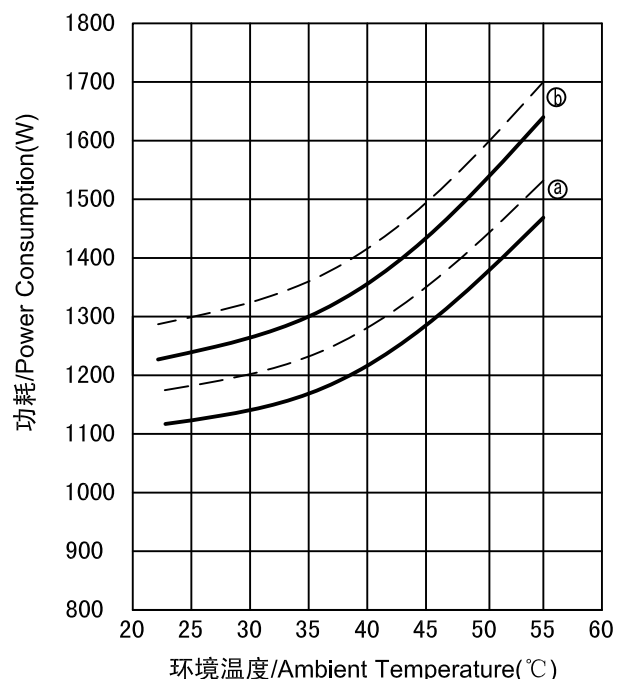
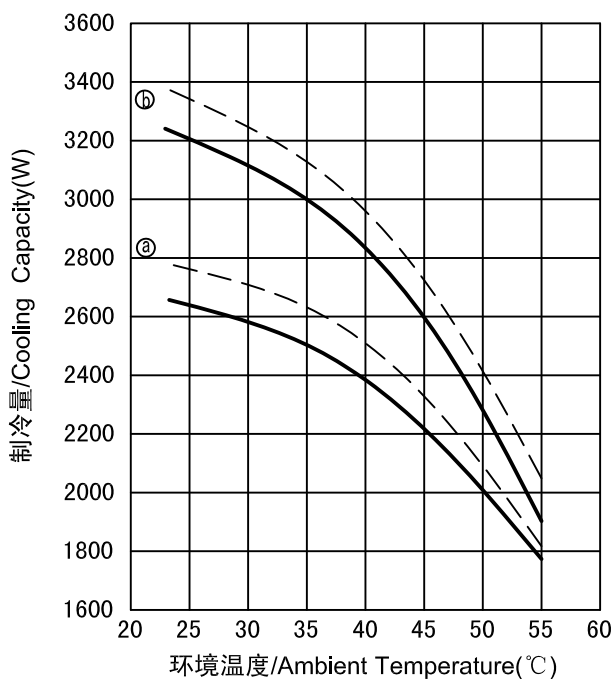

柜内温度 ㉑---25℃ 50Hz
Cabinet Inside Temperature ㉒---35℃ 60Hz

柜内温度 ㉑---25℃ 50Hz
Cabinet Inside Temperature ㉒---35℃ 60Hz

外形尺寸 / Product Dimensions

产品代码/Code	产品型号/Model	安装方式/Installation	
88130	JGLC A 030/M/S/A	侧装/Side Mounting	

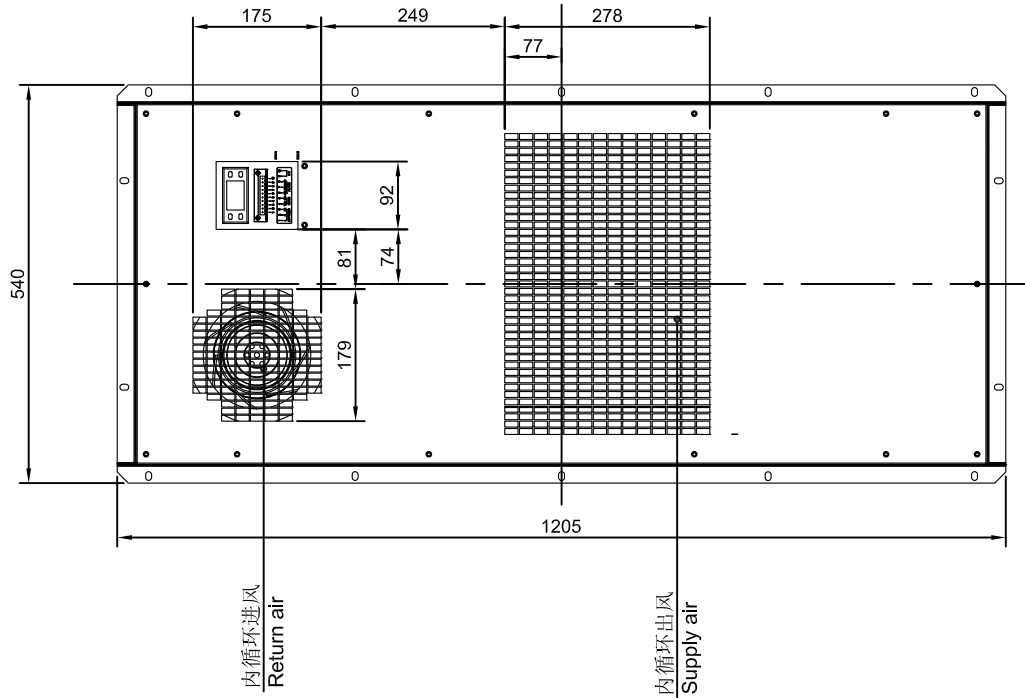

内循环/Internal

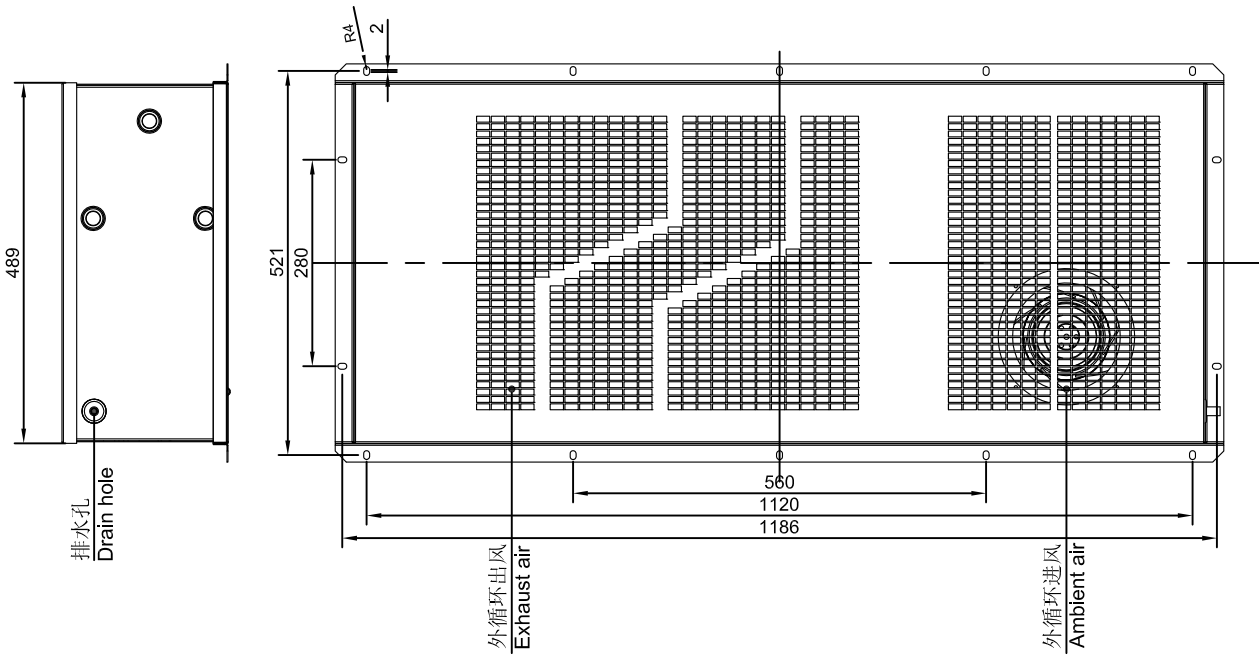
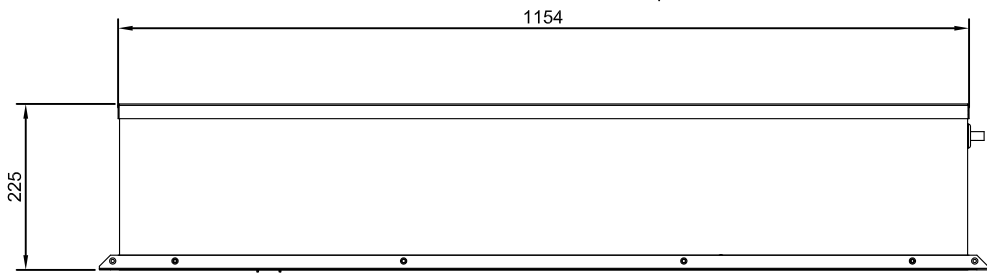

外循环/External

排水孔
Drain hole

外循环出风
Exhaust air

外循环进风
Ambient air

安装尺寸 / Installation Dimensions

产品代码/Code	产品型号/Model	安装方式/Installation	
88130	JGLC A 030/M/S/A	侧装/Side Mounting	

柜门开孔尺寸/Cabinet's Door Cutting Dimensions

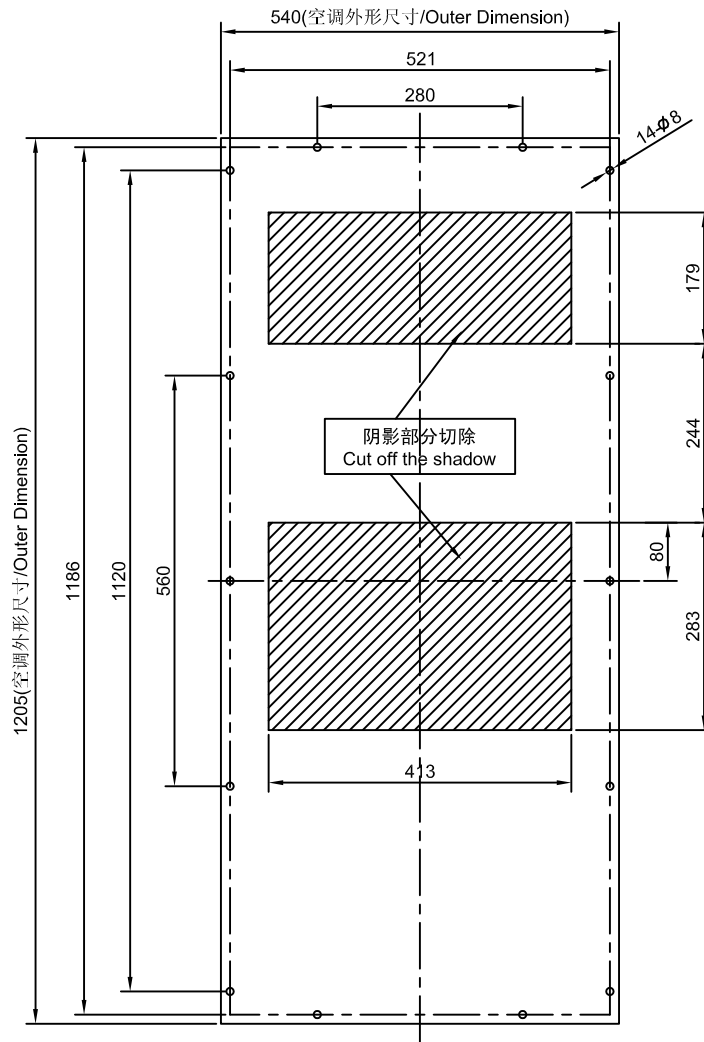

安装图示/Installation Diagrams

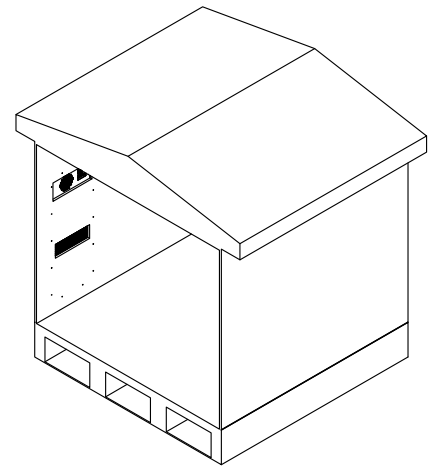
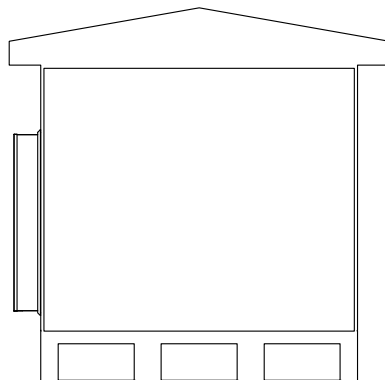
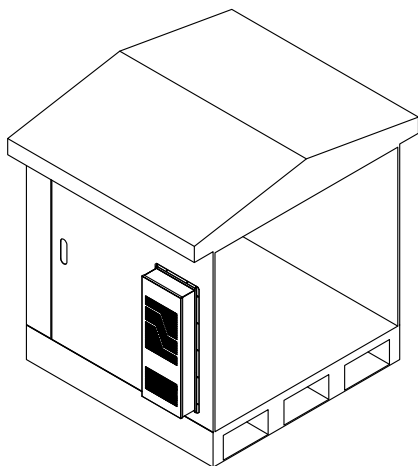

外形尺寸 /Product Dimensions

产品代码/Code	产品型号/Model	安装方式/Installation	
88130	JGLC A 030/M/D/A	门装/Door Mounting	

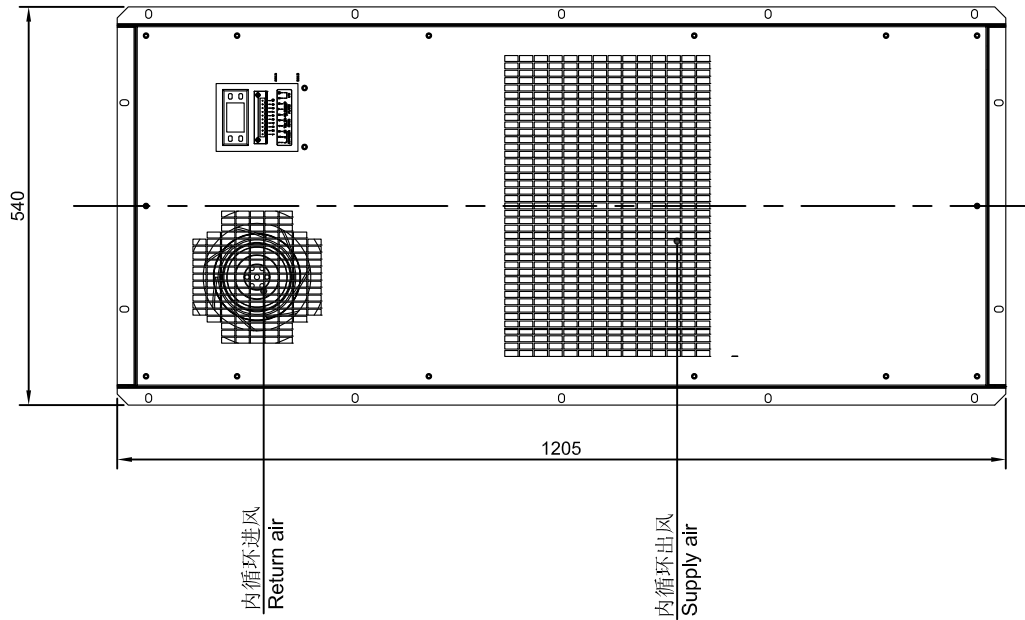

内循环/Internal

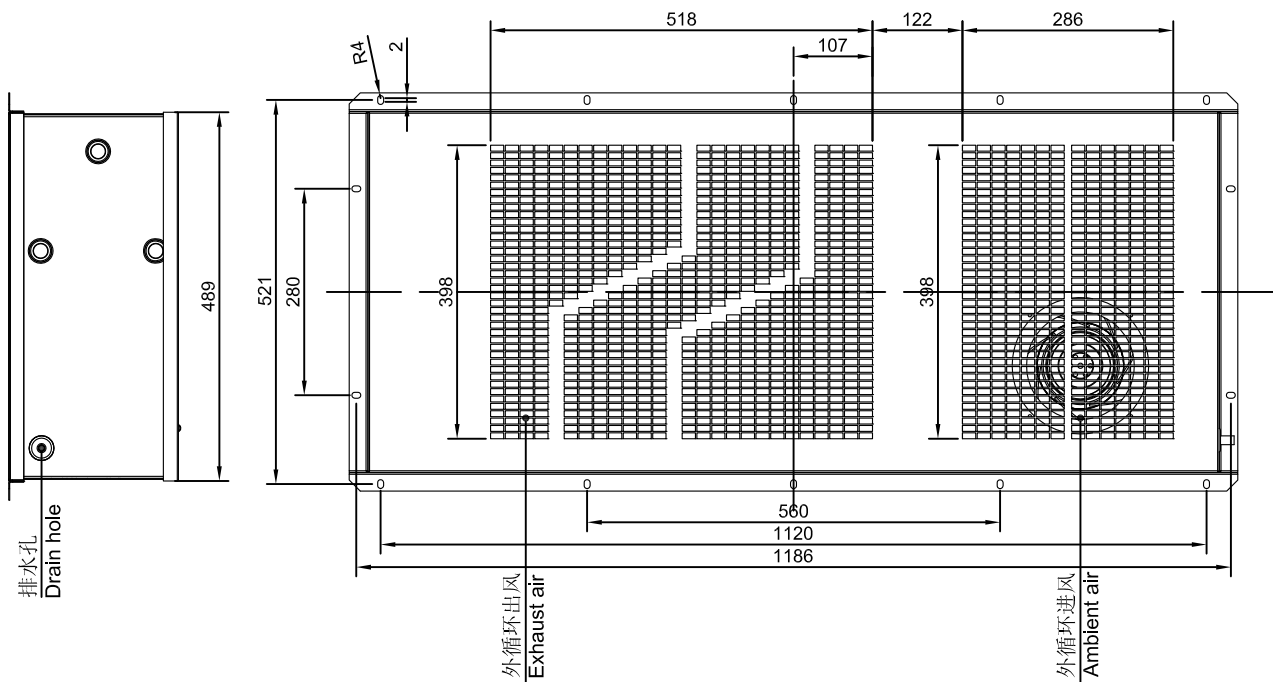
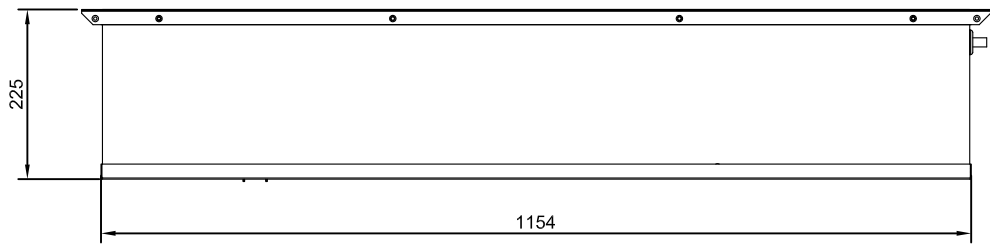

外循环/External

安装尺寸 / Installation Dimensions

产品代码/Code	产品型号/Model	安装方式/Installation	
88130	JGLC A 030/M/D/A	门装/Door Mounting	

柜门开孔尺寸/Cabinet's Door Cutting Dimensions

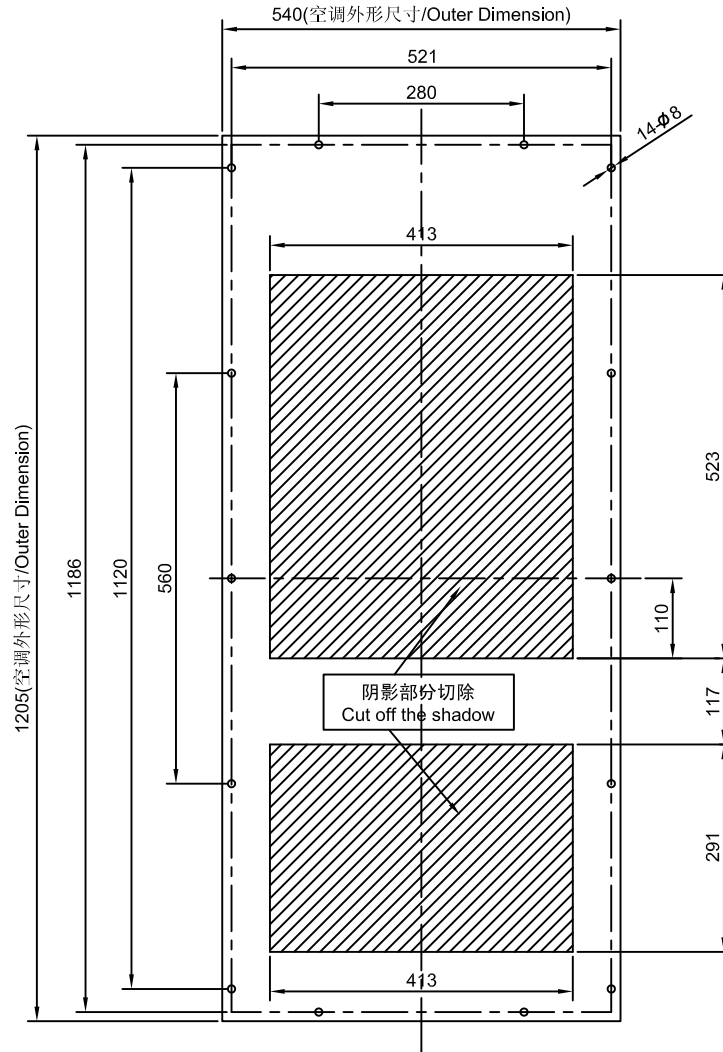

安装图示/Installation Diagrams

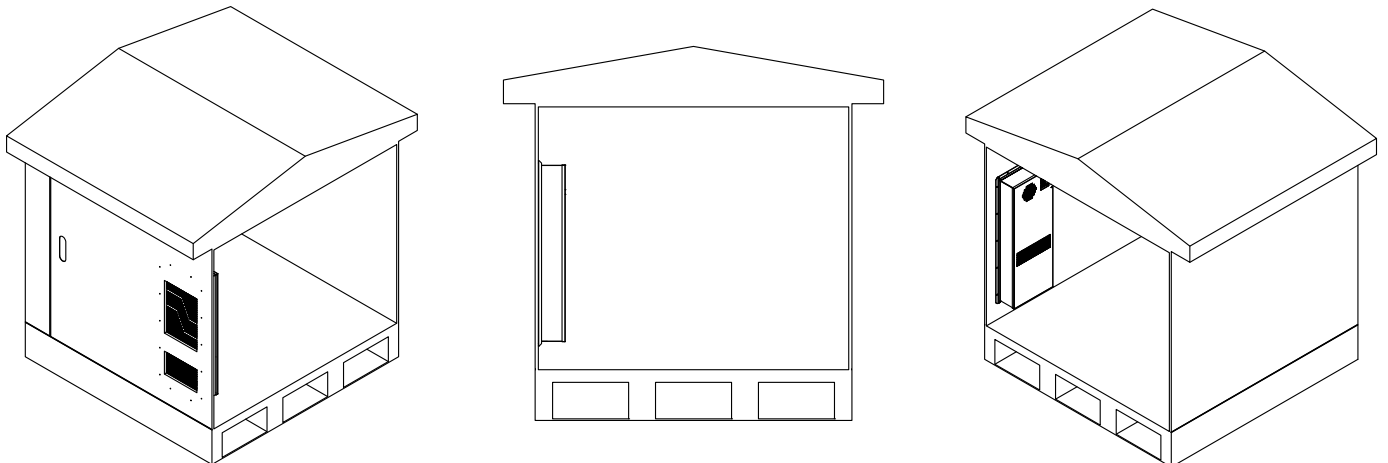

外形尺寸 / Product Dimensions

产品代码/Code	产品型号/Model	安装方式/Installation	
88130	JGLC A 030/M/E/A	半嵌入/Semi-embedded Mounting	

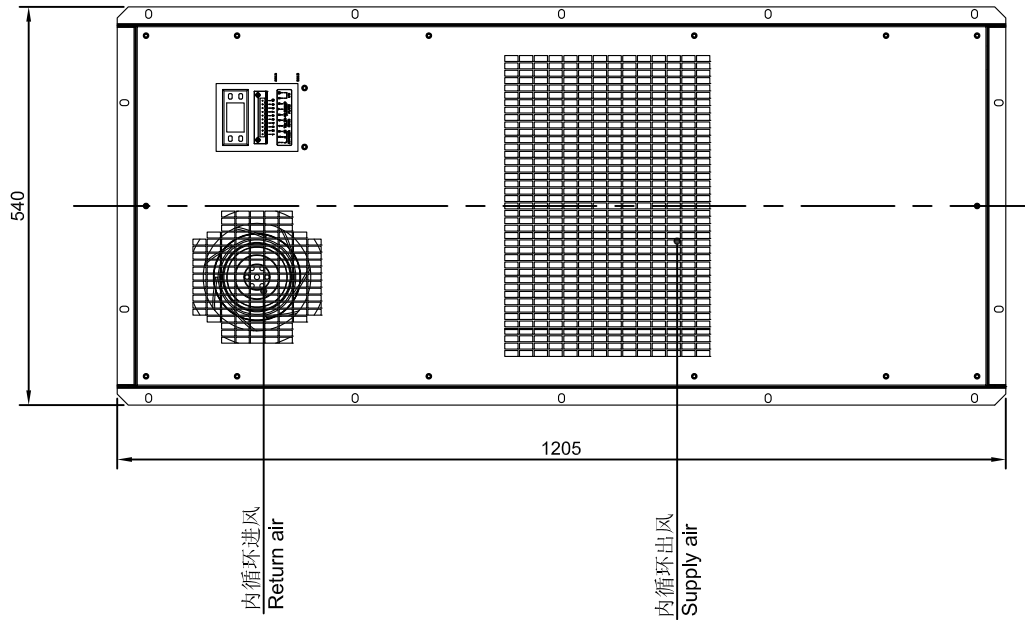

内循环/Internal

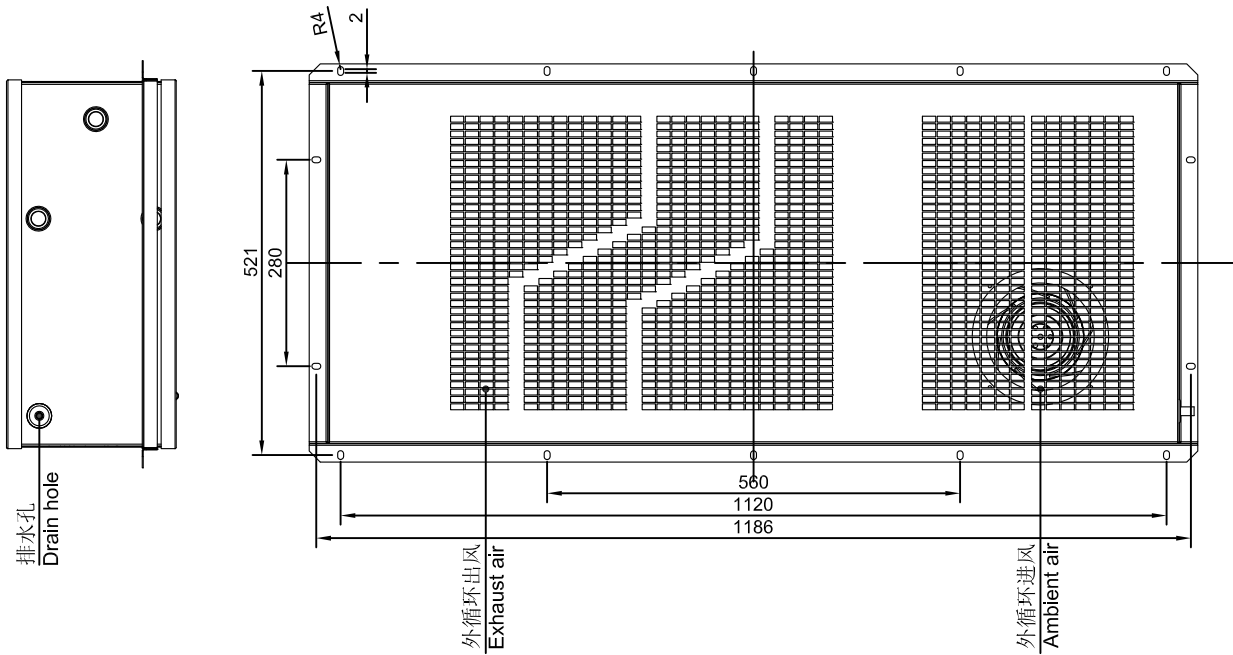
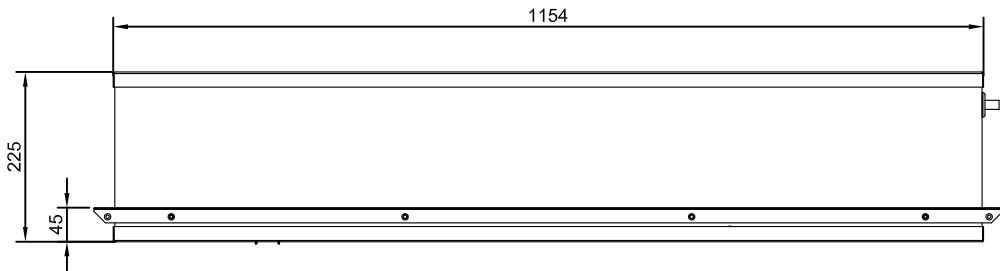

外循环/External

安装尺寸 / Installation Dimensions

产品代码/Code	产品型号/Model	安装方式/Installation	
88130	JGLC A 030/M/E/A	半嵌入/Semi-embedded Mounting	

柜门开孔尺寸/Cabinet's Door Cutting Dimensions

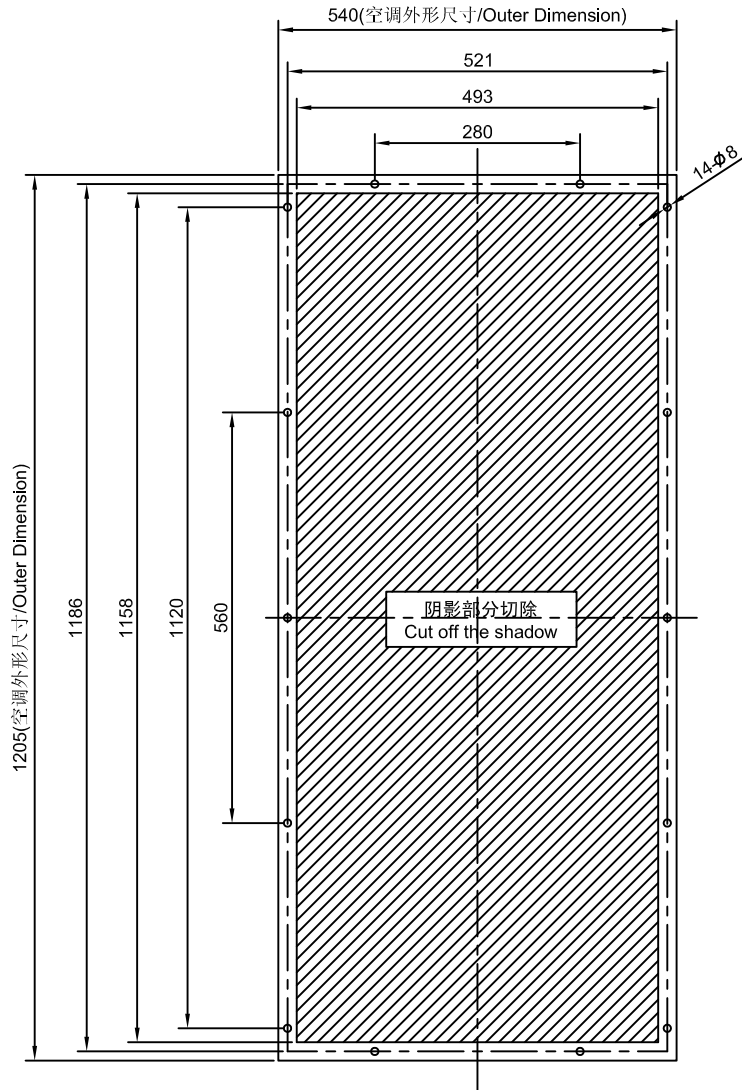

安装图示/Installation Diagrams

